

AZ ADJUSTABLE CHUCK

AZ 可調精度刀柄

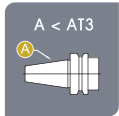

Taper tolerance
錐度公差

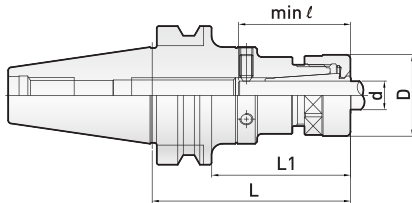
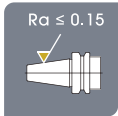

Surface roughness
表面粗度

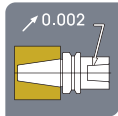

Run out accuracy
內孔偏擺度



Surface hardness
表面硬度

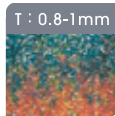

Carbonized depth
滲碳深度

Order Code 訂購編號	Range(d) 夾持範圍	L	L1	Min ℓ 最小長度	T spanner 調整扳手	Nut 螺帽	Spanner 扳手
BT30-SD6-AZ-70	2~6	70	48	35	30194-632	CN-SD6A	30194-917
SD10-AZ-75	2~10	75	53	40	30194-632	CN-SD10A	30194-925
BT40-SD6-AZ-90	2~6	90	63	35	30194-632	CN-SD6A	30194-917
SD10-AZ-90	2~10	90	63	40	30194-632	CN-SD10A	30194-925
SD13-AZ-90	3~13	90	63	49	30194-632	CN-SD13A	30194-932
BT50-SD13-AZ-100	3~13	100	62	49	30194-632	CN-SD13A	30194-932

- The tool tip position can be adjusted as "O" position.
- The accumulated error value of the spindle, the chuck and the tool can all be adjusted and corrected at the same time.
- 刀尖位置可調整至 "O" 位置。
- 機械主軸、夾頭、刀具的累積誤差值可一次調整補正。



SD COLLET (D TYPE)

SD 筒夾 (D型)

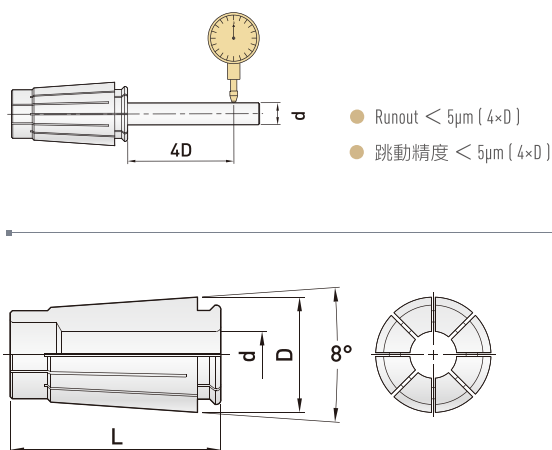

SD6

Order Code 訂購編號	d	Range(d) 夾持範圍	L	D
SD6-2D	2	1.75~2.00	25	11
2.25D	2.25	2.00~2.25		
2.5D	2.5	2.25~2.50		
2.75D	2.75	2.50~2.75		
3D	3	2.75~3.00		
3.5D	3.5	3.00~3.50		
4D	4	3.50~4.00		
4.5D	4.5	4.00~4.50		
5D	5	4.50~5.00		
5.5D	5.5	5.00~5.50		
6D	6	5.50~6.00		

- Gripping range is 0.25mm for collets below 3mm. Gripping range is 0.5mm for collets above 3mm.
- Collets with 3 series, can grip drills, taps, reamers and end mills between 2mm-13mm.
- 3mm以下筒夾，每一個筒夾有0.25mm的夾持範圍；3mm以上筒夾，每一個筒夾有0.5mm的夾持範圍。
- 筒夾分為3大系列，可夾持2mm~13mm的鑽頭、絲攻、絞刀、銑刀。

SD10

Order Code 訂購編號	d	Range(d) 夾持範圍	L	D
SD10-2D	2	1.75~2.00	30	16
2.25D	2.25	2.00~2.25		
2.5D	2.5	2.25~2.50		
2.75D	2.75	2.50~2.75		
3D	3	2.75~3.00		
3.5D	3.5	3.00~3.50		
4D	4	3.50~4.00		
4.5D	4.5	4.00~4.50		
5D	5	4.50~5.00		
5.5D	5.5	5.00~5.50		
6D	6	5.50~6.00		
6.5D	6.5	6.00~6.50		
7D	7	6.50~7.00		
7.5D	7.5	7.00~7.50		
8D	8	7.50~8.00		
8.5D	8.5	8.00~8.50		
9D	9	8.50~9.00		
9.5D	9.5	9.00~9.50		
10D	10	9.50~10.00		

SD13

Order Code 訂購編號	d	Range(d) 夾持範圍	L	D
SD13-3D	3	2.75~3.00	39	20
3.5D	3.5	3.00~3.50		
4D	4	3.50~4.00		
4.5D	4.5	4.00~4.50		
5D	5	4.50~5.00		
5.5D	5.5	5.00~5.50		
6D	6	5.50~6.00		
6.5D	6.5	6.00~6.50		
7D	7	6.50~7.00		
7.5D	7.5	7.00~7.50		
8D	8	7.50~8.00		
8.5D	8.5	8.00~8.50		
9D	9	8.50~9.00		
9.5D	9.5	9.00~9.50		
10D	10	9.50~10.00		
10.5D	10.5	10.00~10.50		
11D	11	10.50~11.00		
11.5D	11.5	11.00~11.50		
12D	12	11.50~12.00		
12.5D	12.5	12.00~12.50		
13D	13	12.50~13.00		

SD COLLET (E TYPE)

SD 筒夾 (E型)

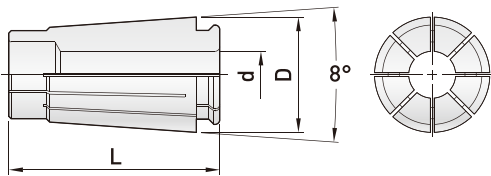
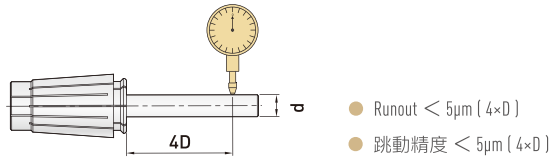

- Gripping torque of SD-E collets is 20% more than SD-D Collets. Can reach high stability during milling.
- Special designed for end mill.

- SD-E筒夾比SD-D筒夾多20%的夾持力，在夾持銑刀加工時，更為安定。
- 立銑刀專用夾頭。

SD6

Order Code 訂購編號	d	(d) 持夾徑	L	D
SD6-3E	3	3	25	11
4E	4	4		
6E	6	6		
1/8E	3.175	3.175		

SD10

Order Code 訂購編號	d	(d) 持夾徑	L	D
SD10-3E	3	3	30	16
4E	4	4		
5E	5	5		
6E	6	6		
8E	8	8		
10E	10	10		
1/8E	3.175	3.175		

SD13

Order Code 訂購編號	d	(d) 持夾徑	L	D
SD13-3E	3	3	39	20
4E	4	4		
5E	5	5		
6E	6	6		
8E	8	8		
10E	10	10		
12E	12	12		
1/8E	3.175	3.175		

SD16

Order Code 訂購編號	d	(d) 持夾徑	L	D
SD16-4E	4	4	45	25
5E	5	5		
6E	6	6		
8E	8	8		
10E	10	10		
12E	12	12		
14E	14	14		
16E	16	16		

SD20

Order Code 訂購編號	d	(d) 持夾徑	L	D
SD20-6E	6	6	50	30
8E	8	8		
10E	10	10		
12E	12	12		
14E	14	14		
16E	16	16		
20E	20	20		

SD COLLET (F TYPE)

SD 筒夾 (F型)

- SD-F collet provide through-coolant capability.
- The collet combine with nut.
- SD-F筒夾具有中心出水的功能。
- 筒夾出貨時，內含螺帽。



F Type Collet / F型 筒夾



Fig 2 / 圖號 2



Fig 1 / 圖號 1

Order Code 訂購編號	Chuck Type 刀柄規格	(d) 持夾徑	Contains 內容		Fig 圖號
			Collet 筒夾	Nut 螺帽	
SAC10- 3F	SD10	3	SD10- 3F	CN-SD10A	1
4F		4	4F		
6F		6	6F		
8F		8	8F		
10F		10	10F		
SAM10- 3F	SD10	3	SD10- 3F	CN-SD10AM	2
4F		4	4F		
6F		6	6F		
8F		8	8F		
10F		10	10F		
SAC13- 3F	SD13	3	SD13- 3F	CN-SD13A	1
4F		4	4F		
5F		5	5F		
6F		6	6F		
8F		8	8F		
10F		10	10F		
12F	12	12F			
SAM13- 3F	SD13	3	SD13- 3F	CN-SD13AM	2
4F		4	4F		
5F		5	5F		
6F		6	6F		
8F		8	8F		
10F		10	10F		
12F	12	12F			
SAC16- 6F	SD16	6	SD16- 6F	CN-SD16A	1
8F		8	8F		
10F		10	10F		
12F		12	12F		
14F		14	14F		
16F		16	16F		
SAM16- 6F	SD16	6	SD16- 6F	CN-SD16AM	2
8F		8	8F		
10F		10	10F		
12F		12	12F		
14F		14	14F		
16F		16	16F		

SD NUT (AC TYPE)

SD 螺帽 (AC型)



Fig 1 / 圖號 1



Fig 2 / 圖號 2

Order Code 訂購編號	Fig 圖號	Outside Dia 外徑	Collet 筒夾規格
CN-SD6A	1	20	SD6
SD10A	1	29	SD10
SD13A	1	37	SD13
SD16A	1	41	SD16
SD20A	2	50	SD20

SD NUT (AM TYPE)

SD 螺帽 (AM型)



Order Code 訂購編號	Outside Dia 外徑	Collet 筒夾規格
CN-SD6AM	20	SD6
SD10AM	30	SD10
SD13AM	35	SD13
SD16AM	42	SD16

SD NUT (B TYPE)

SD 螺帽 (B型)



Order Code 訂購編號	Collet 筒夾規格
CN-SD20B	SD20

SPANNER

扳手



Fig 1 / 圖號 1

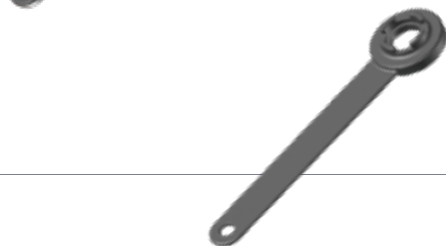

Fig 2 / 圖號 2

Order Code 訂購編號	Fig 圖號	Type 型式
30194-917	1	SP-SD6
925	1	SP-SD10
932	1	SP-SD13
936	1	SP-SD16
702	2	SP-SD20



Order Code 訂購編號	Type 型式	Nut 螺帽規格
30194-820	SP-SR20	SD6AM
30194-830	SP-SR30	SD10AM
30194-835	SP-SR35	SD13AM
30194-842	SP-SR42	SD16AM



Order Code 訂購編號
SP-SD20B